

HDL[®]

HDL{Enviro panel}

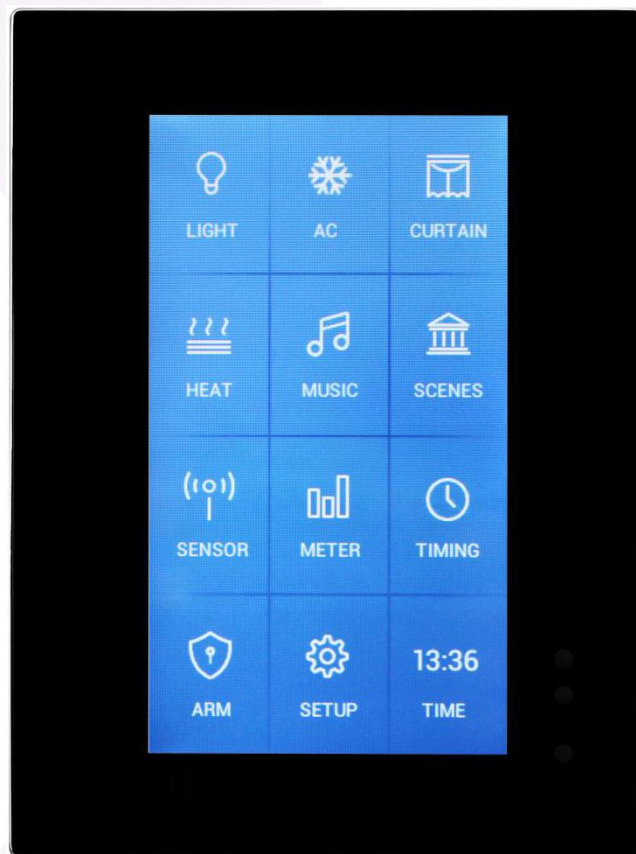

{HDL-MPTLC43.46}

Notices

Disclaimer

Any changes or modifications made to the module which have not been expressly approved by HDL will void the product warranty.

The module can only be serviced by HDL trained technicians, the use of outside agencies to service any HDL product will void the product warranty.

This module must be installed and used in strict accordance to the HDL instructions, as detailed in the relevant HDL user documentation.

HDL reserves the right to make changes to any and all parts of HDL hardware, software, and this publication at any time, without any obligation to notify any person or entity of such changes.

Trademarks

HDL, the HDL logo, Buspro, and Buspro wireless are the trademarks of HDL Automation. Any other trademarks, registered trademarks, or trade names used in this document refer solely to the entities claiming these marks.

This document was created by the HDL Technical Documentation department:

HDL®

No.86 LianHuaXi Rd. Lifeng Avenue, Panyu District

Guangzhou, China

Tel: 0086 020-846 516 66 Fax: 0086 020-85520532

Contents

1. Introduction.....	1
1.1 Functionality.....	1
1.2 Parameters.....	2
1.3 Product Description.....	3
2. Setup.....	4
2.1 Connections.....	4
2.2 Maintenance and Warranty.....	7
3. System Configuration.....	7
3.1 Basic Information.....	7
3.2 UI Customized.....	9
3.3 Button Page.....	12
3.4 AC Page.....	17
3.4.1 HVAC Control.....	19
3.4.2 UV Switch Control.....	20
3.5 Floor Heating Page.....	23
3.6 Music Page.....	26
3.7 Modify the Icon and Remark.....	30
3.8 Upgrade.....	33
4. Customer Service and Technical Support.....	36

1. Introduction

HDL-MPTLC43.46 Multi-function touch LCD panel, it has normal version and XL version. There are 10 pages totally, user can customize each page interface personally. Moreover, AC function support UV switch control, can work with SB-IR-EM, 8in1 sensor, 12in1 sensor.

1.1 Functionality

- UI customized
- Built-in temperature sensor
- Adjustable LCD backlit
- Wake up function
- According to the time, will change standby interface automatically, the screen will be dark and enter the power saving mode
- Normal control: light icons for lighting/curtain/scene control, support 36 buttons.
- AC control: support 9 areas independently, only the first 3 ACs support UV switch control.
- Floor heating control: support 9 areas independently.
- Music control: support 9 zones independently.
- Support 10 pages, can assign the lighting/AC/floor heating/music/setup/timer button to each page.
- Password protection, one password for whole panel.
- Supports more SETUP buttons and more TIMER buttons
- TIMMER function: can display the date, time, temperature, etc

- Key mode: Invalid, Single on/off, Single on, Single off, Combination on, Combination off, Combination on/off, Short press/Long click, Short press/Long press
- Key control mode: Scene, Sequence, Timer switch, Single channel on-off, Broadcast scene, Broadcast channel, Curtain, GPRS control, Panel control, Broadcast Scene, Broadcast Channel, Security Module, Link Page, Logic Light Adjust, Logic Scene, LCD&LED Sleep, etc.
- Panel functions: Lock, Turn on/off AC, cooling & heating for AC, Auto temperature setting, Fan Speed regulating, AC Mode setting, AC Temperature regulating, backlight adjusting, AC Lock, Backlight and status indicator light setting, floor heating temperature and mode setting etc.
- Support to change the button position/button remark/button icon/background picture
- Support online upgrading

1.2 Parameters

Electrical Parameters:	
Working voltage	DC12~30V (From HDL-MPPI.46)
Power consumption	165mA /DC24V
Terminal	0.75-0.85 single-core copper cable
Environment conditions:	
Working temperature	-5°C~45°C
Working relative humidity	< 90%
Storage temperature	-20°C~+60°C
Storage relative humidity	< 93%

Approved:	
CE	
RoHS	
Product Information:	
LCD resolution ratio	480x272
Dimension	86×116.5×10.5 (mm) (Normal) 96×126.5×10.5 (mm) (XL)
Weight	129g
Housing material	Glass, PC, ABS
Installation	Wall box
Protection degree	IP20

1.3 Product Description

This chapter is designed to detail the way in which the HDL-MPTC43.46 can be controlled, its connections, the functionality of specific buttons, and the purpose of additional module attributes.”

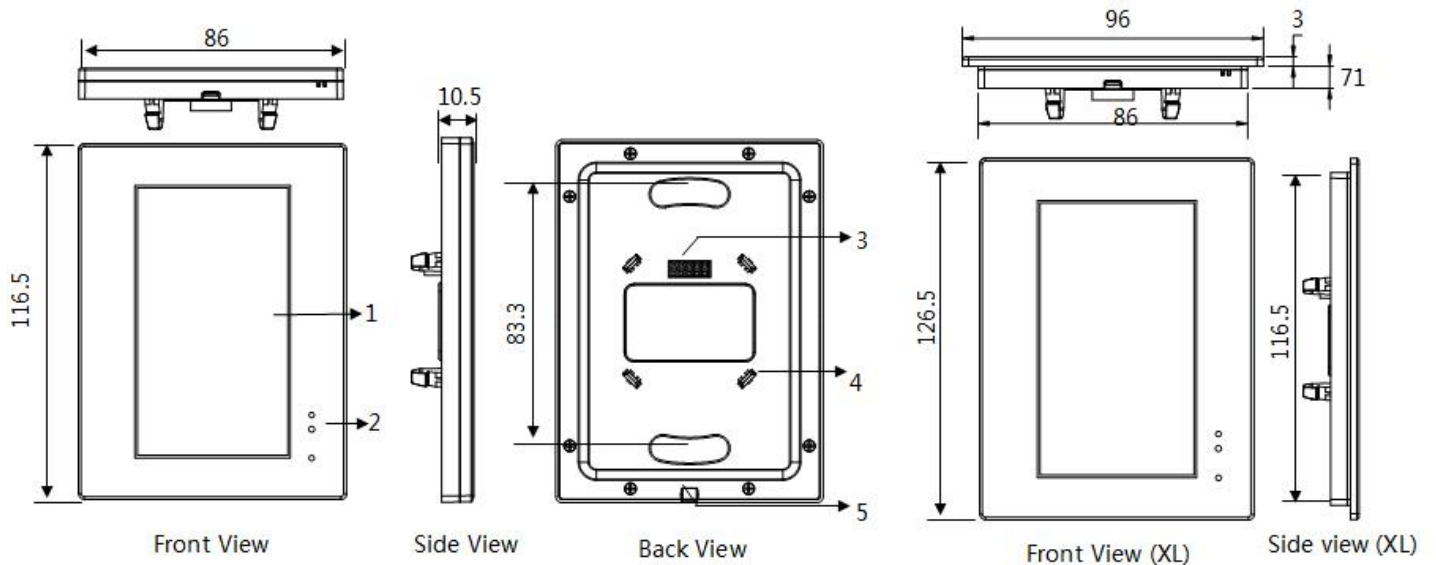

1: LCD screen: display the icon and control

2: Wake up function: IR detection, when people close to the panel, the screen will light up.

3/4: Signal interface and fastener: Connect to panel power interface (MPPI.46)

5: Split gap: Insert a slotted screwdriver to split gap, separate the panel and power module (MPPI.46)

2. Setup

2.1 Connections

In order to ensure that your installed HDL automation solutions operate at peak performance, it is recommended that only HDL certified wire is used. Failure to use wire certified by HDL in an installation may void your HDL product warranty.

CAUTION: Before connecting the module to a power supply, test the power supply voltage and current, to ensure that it matches that of your HDL module.

HDL Buspro Definition for Cable:

HDL Buspro	HDL Buspro/KNX
DC24V	Red
COM	Black
DATA-	White
DATA+	Yellow

Important Notes:

- It must work in conjunction with HDL-MPPI.46
- Buspro connection-Series connection (hand-in-hand)
- Installation-US wall box

Safety Precautions:

- Do not make wrong connection on bus interface, it will damage the bus interface of this module
- Never let liquids get into the module, it will damage this module
- Do not get AC power into bus wire, it will damage all device in the system

Installation Steps:

- Mount the HDL-MPPI.46 in the wall box
- Connect bus cables. Make sure the color of wire complies with the definition
- Make sure the Buspro cable type is correct and has no short circuit
- Put this device into HDL-MPPI.46

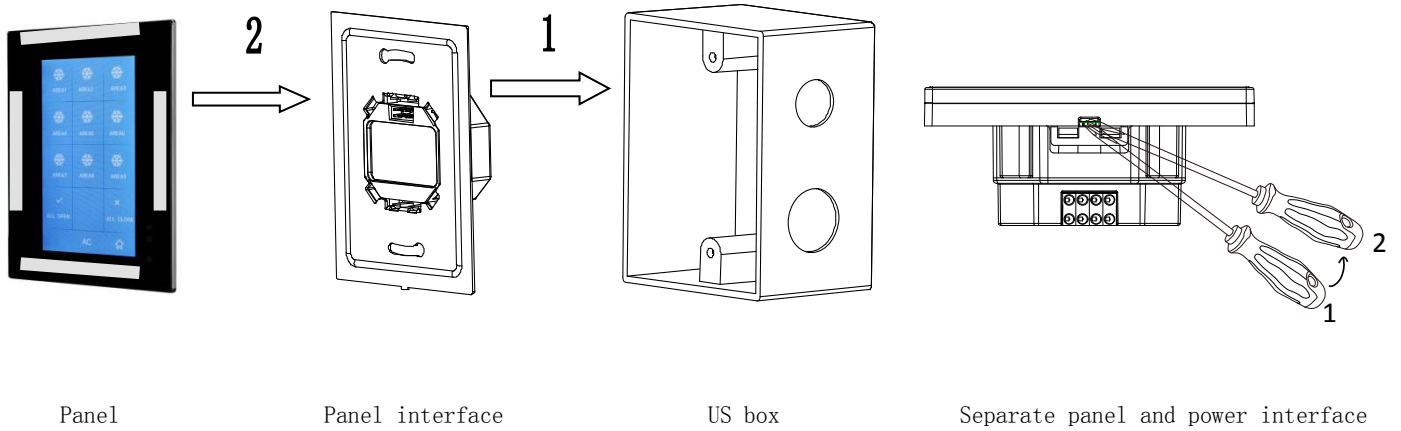

Installation: Hold the edge of the panel (shown as above grey area), insert the power interface module vertically. Do not push the panel too hard.

Split: Insert a 2.5mm-screwdriver to the split gap, pry up from Position 1 to 2, then the wiring hole will be open. Then separate the panel and MPPI.46.

Connections/Wiring:



2.2 Maintenance and Warranty

The HDL (model number) module is designed to be maintenance free, and has a limited two (2) year warranty on parts from the date of installation. This warranty will not exceed the purchase price of the device in question. This warranty does not cover installation, removal, or reinstallation cost. This warranty is not valid in cases where damage was incurred due to misuse, incorrect installation, or through incorrect repair.

To ensure a long service life the (model number) must be installed as per the instructions in this manual.

The module must only be used for the purpose it was designed for.

3. System Configuration

3.1 Basic Information

Use HDL Buspro Design Tool II to search the enviro panel. After searched, will show as below:

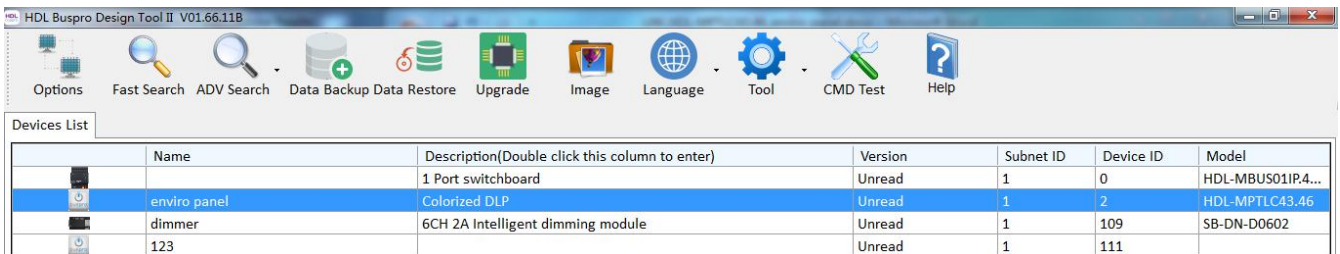

Name	Description(Double click this column to enter)	Version	Subnet ID	Device ID	Model
1 Port switchboard	1 Port switchboard	Unread	1	0	HDL-MBUS01IP.4...
enviro panel	Colorized DLP	Unread	1	2	HDL-MPTLC43.46
dimmer	6CH 2A Intelligent dimming module	Unread	1	109	SB-DN-D0602
123		Unread	1	111	

Name:

Double click this area, can change the remark of this device.

Version:

Double click this area, can read the firmware of this device.

Subnet ID, Device ID:



Double click this area, can modify the address of device. Or you can modify the address in the SETUP button on the panel.

Notice: When you modify the address, you need to read the MAC first. The Device ID should be unique in its Subnet, and the Subnet ID should be kept consistent with the Gateway (typically the SB-DN-1IP or HDL-MBUS01IP.431)

Double click the ‘Description’ area, enter to the programming interface:

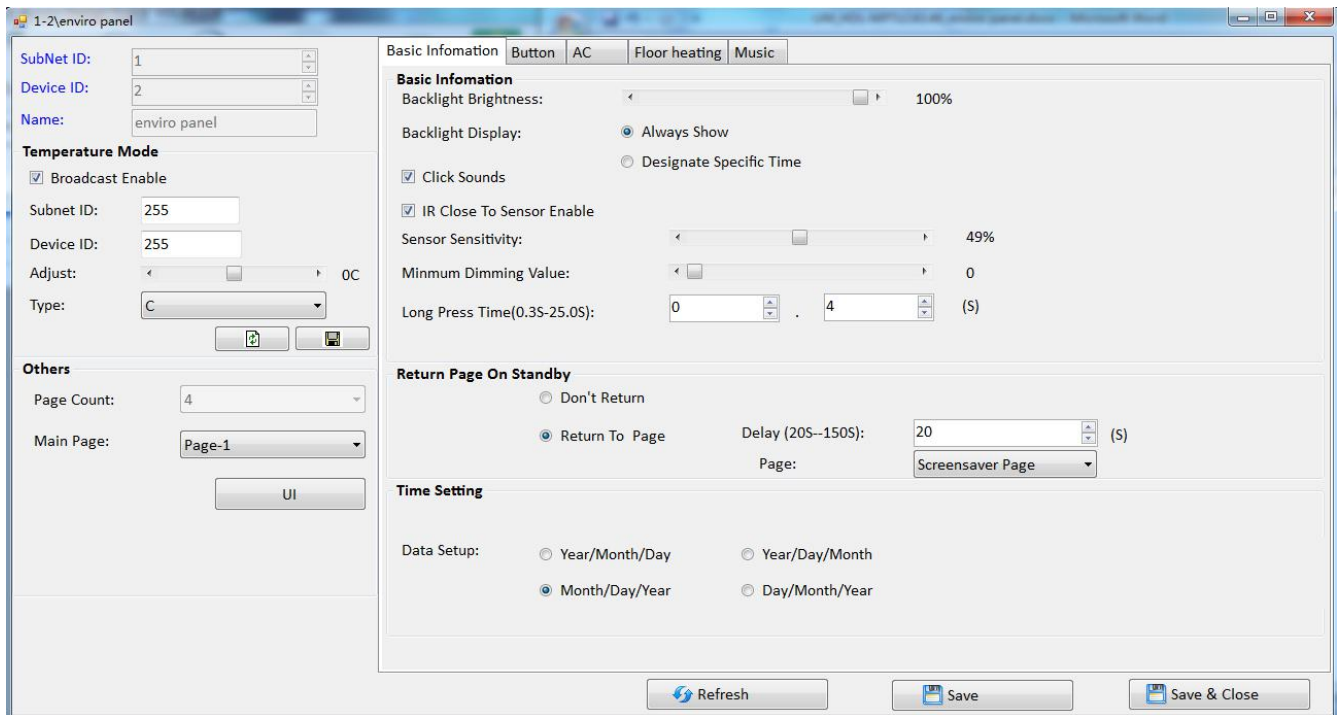

Temperature Mode: This panel built-in temperature sensor, can broadcast the temperature to the BUS. If the detected temperature has error, you can adjust it on the software.

Backlight Brightness: Can set the backlight brightness.

Backlight Display: Can set the backlight always display; or enter to the standby mode in designate specific time when there is no operation.

Click Sounds: when touch the panel to control targets, it will come with sound.

IR Close To Sensor Enable: When the panel in standby mode. If enable this function, the backlight will be on when your hand close to the panel. If not enable this function, the backlight will be on when you click the panel.

Notice: Can set the Sensor Sensitivity in the software.

Minimum Dimming Value: Set the dimming lower limit. The lower limit is useful if you would like to skip the low level segment and dim from a certain level, say 40%. You want to skip it because maybe lower than 40% is impractical for you or maybe the load quality is not so good and trembles when at low level segment.

Long Press Time: Define the long press time.

Return Page On Standby: Do not return or return to specific page when there is no operation.

Time Setting: Set the format of time

Notice: This panel does not have real time clock chip, it only can receive the time from other module (like logic module, security module) on the BUS, then display it.

3.2 UI Customized

Enviro panel has 10 pages, and user can customize the content for each page. You need to design the interface before you program it.

After searched the enviro panel on software, go to 'Basic Information' page, there has 'Other' option.

The screenshot shows a software configuration window with two main sections. The 'Others' section on the left is highlighted with a red border and contains a 'Page Count' dropdown set to '4', a 'Main Page' dropdown set to 'Page-1', and a 'UI' button. The 'Return Page On Standby' section on the right has two radio buttons: 'Don't Return' (unselected) and 'Return To Page' (selected). To the right of these are a 'Delay (20S--150S):' field set to '20' with '(S)' next to it, and a 'Page:' dropdown set to 'Screensaver Page'. Below this is a 'Time Setting' section.

Page Count: Display the page count.

UI: Entrance UI design page.

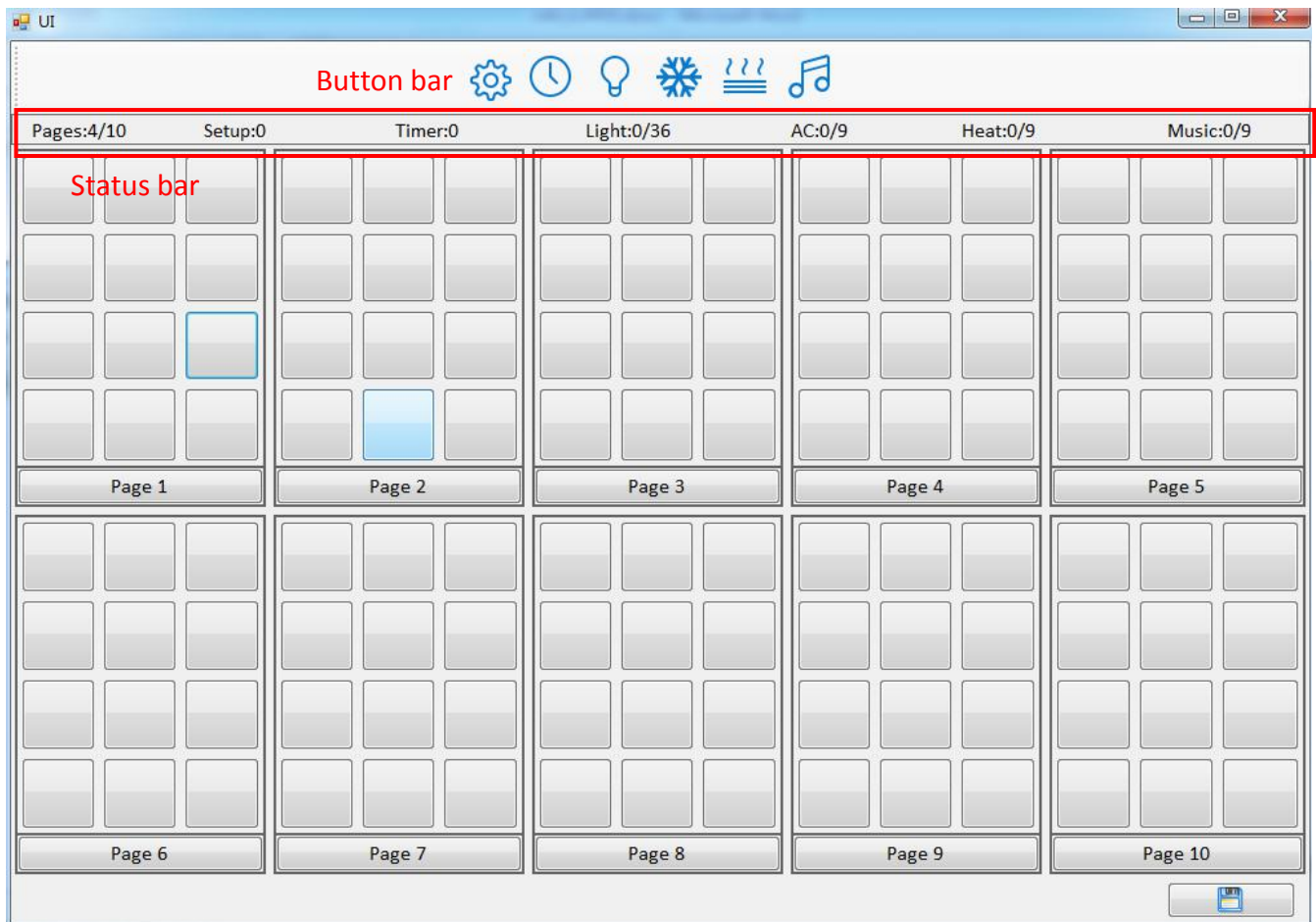

Button bar: There has 'SETUP, TIMER, LIGHT, AC, FLOOR HEATING, MUSIC' buttons.

Status bar:

Pages:4/10 : Total 10 pages, currently using four pages.

Setup:1/Timer:1 : Total one SETUP/TIMER button, but can put it in more pages.

Lights: 0/36 : Total 36 buttons, currently no one used.

AC:0/9、 Heat:0/9、 Music:0/9: Total 9 AC/Floor heating/music button, currently no one used.

Steps for UI design:

1: Select the button on Button Bar, and drag it to the page. Right click to delete the existing one.

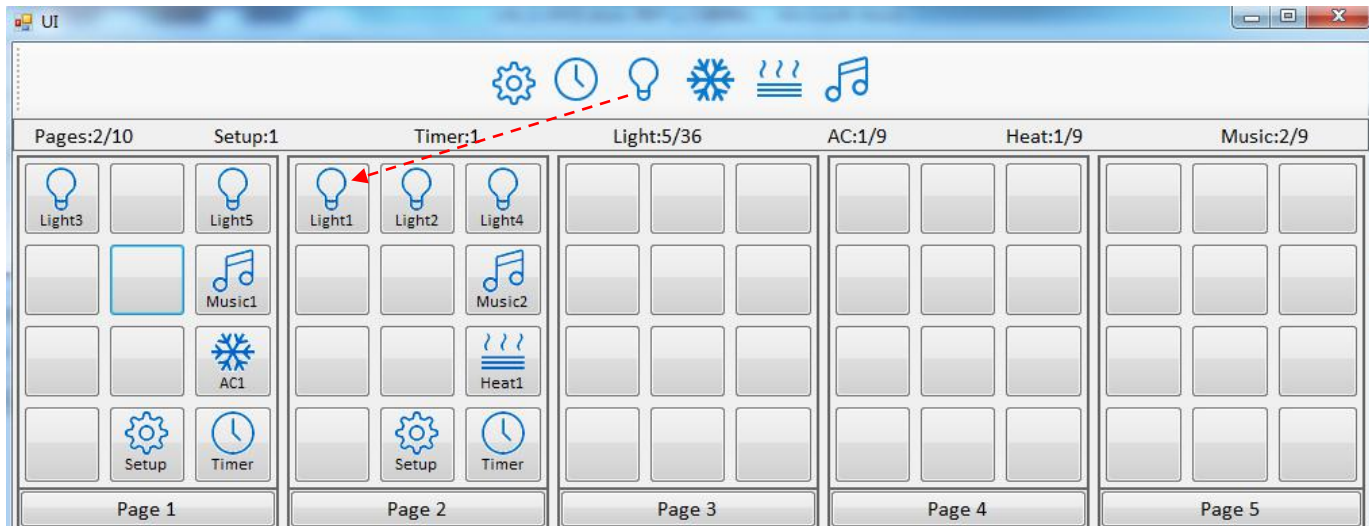

2: Also you can drag the button in the page. **When drag the button, the control target of this button will be moved together.**

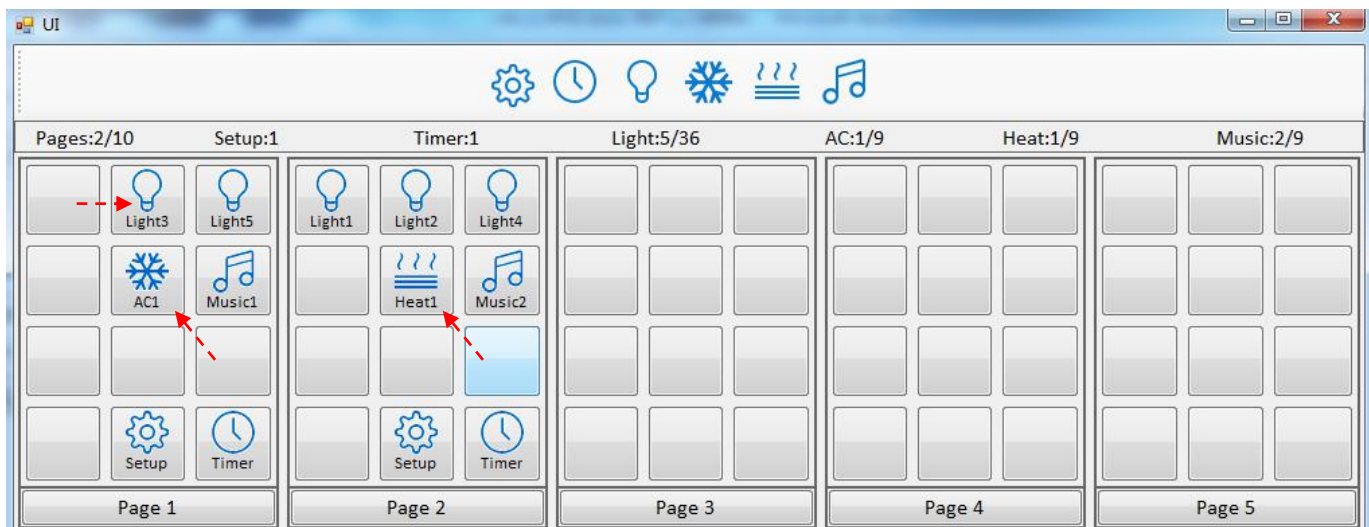

3: Click 'Save' button.

4: Done.

3.3 Button Page

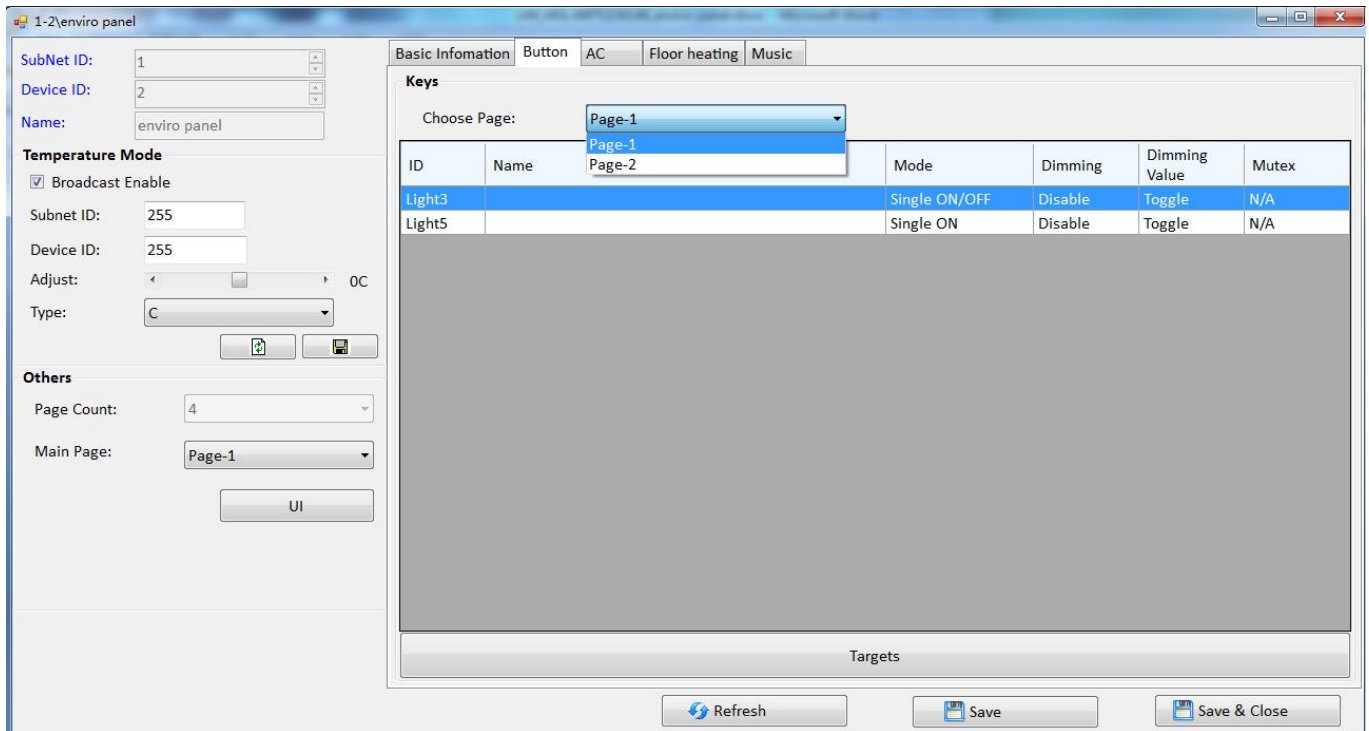

Choose Page: Display the page count of button, need to select the page before you program the buttons.

ID: The button's ID

See below picture, in page1, just has 2 lights (Light3 and Light5).

The ID is unique, it will not be changed even you change the button icon and button remark.

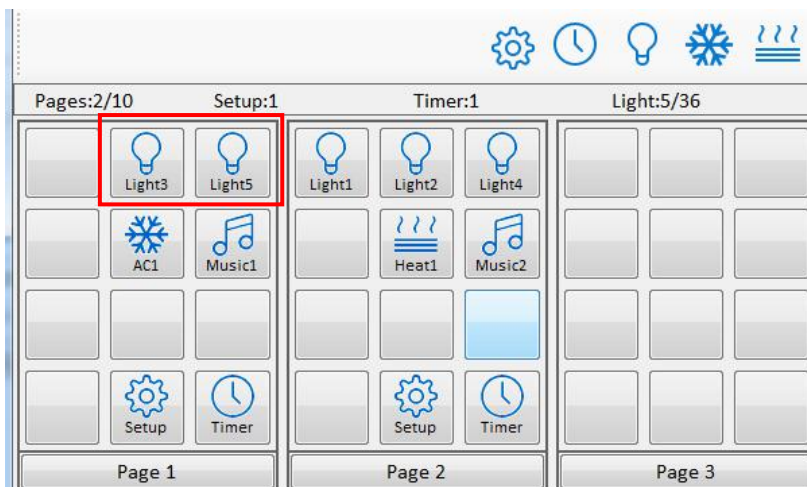

Mode:

■ **Invalid:**

If this is assigned the Switch can not be used.

■ **Single on:**

If this is assigned the Switch can turn on one target only (one channel, one scene, one sequence, etc)

■ **Single off:**

If this is assigned the Switch can turn off one target only (one channel, one scene, one sequence, etc)

■ **Single on/off:**

If this is assigned the Switch can turn on/off one target only (one channel, one scene, one sequence, etc)

■ **Combination on:**

If this is assigned the Switch can turn on multiple targets (channels, scenes, sequences, etc)

■ **Combination off:**

If this is assigned the Switch can turn off multiple targets (channels, scenes, sequences, etc)

■ **Combination on/off:**

If this is assigned the Switch can turn on/off multiple targets (channels, scenes, sequences, etc)

■ **Short Press/Long Jog:**

Both can control up to 49 targets.

Press one time, trigger the Short Press targets.

Long press trigger the ON status, release the finger trigger the OFF status.

■ **Short/Long Press:**

Both can control up to 49 targets.

Dimming:

Valid: Enable dimming when long pressed.

Invalid: Disable dimming, just on/off.

Dimming Value:

Toggle: If selected, when turn on light, the brightness will go to 100%.

Memory: If selected, when turn on light, the brightness will go to last brightness before turn off.

Mutual exclusion:

There are 20 mutual exclusion groups available, they only work for combination mode button. After a mutual exclusion group has been set, only the last key controlled can indicate its status (on), the status of other keys in mutual exclusion group will be off.

ID	Name	Mode	Dimming	Dimming Value	Mutex
Light3	scene 1	Combination ON	Disable	Toggle	1
Light5	scene 2	Combination ON	Disable	Toggle	1

Group

The mutual exclusion groups can enable the scenarios described below:

Key1 control (combination on) channel1 and channel2 with a dimming level of 30%.

Key2 control (combination on) channel1 and channel2 with a dimming level of 80%.

When no mutual exclusion:

Press key1, and then press key2, two channels are go to 80%, But both led indicators will turn on.



When has mutual exclusion:

Press key1, and then press key2, two channels are go to 80%, And just the key2 led indicator will stay on.

Targets:

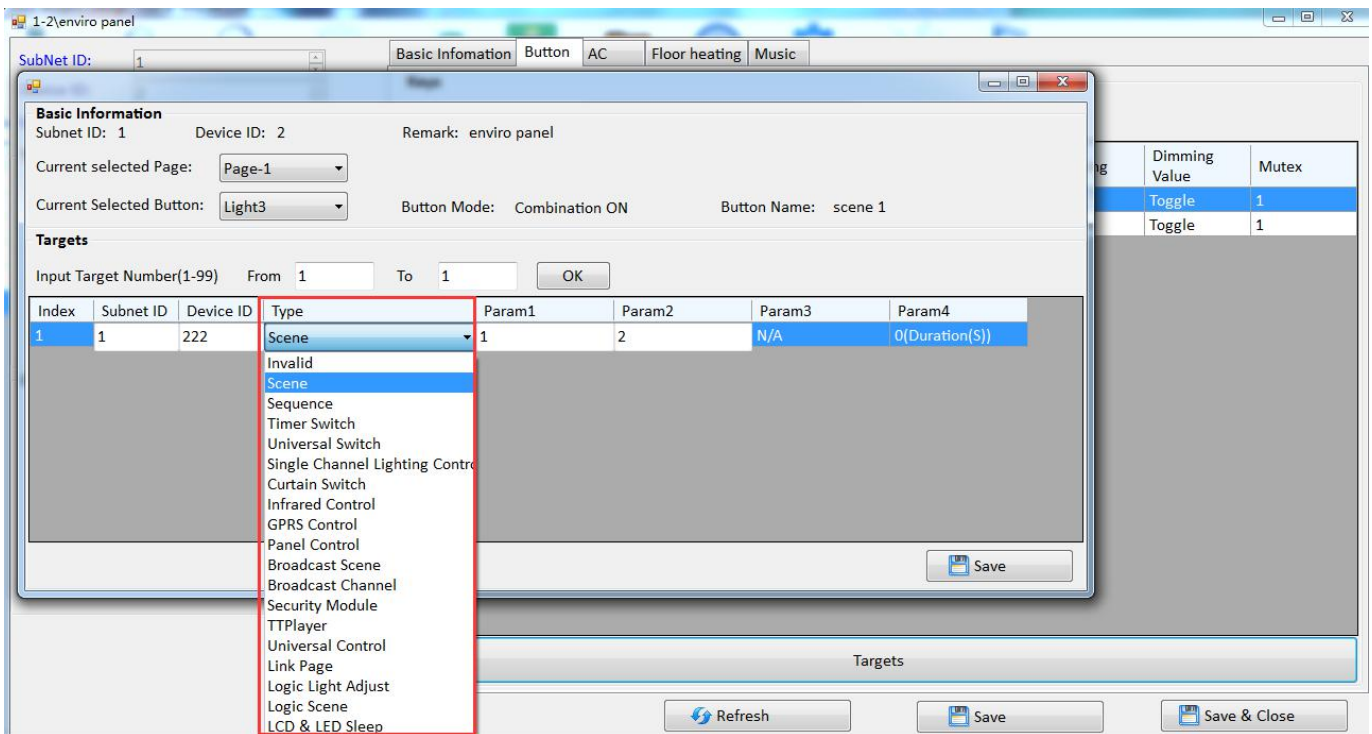

Type:

■ Scene:

Enables a user to turn a scene on or off.

■ Sequence:

Enables a user to turn a sequence on or off.

■ Universal Switch:

Send the UV command.

■ Single Channel Lighting Control:

Enables a user to turn a channel on or off.

■ **Curtain Switch:**

Enables a user to control the curtain module.

■ **Infrared Control:**

Work with new generation IR emitter HDL-MIRC04.40.

■ **GPRS Control:**

Enables a user to send message via SMS module.

■ **Panel Control:**

Shield button/page, control the AC and floor heating module, etc.

■ **Broadcast Scene:**

Enables a user to control the same scene in all area.

■ **Broadcast Channel:**

Enables a user to turn on/off all the channels in one Dimmer, Relay, etc.

■ **Security Module:**

Enables a user to control the security module.

■ **TT Player:**

Enables a user to control the Z-audio module.

■ **Universal Control:**

Enables a user to modify the basic settings of a device from a panel. This feature makes the system more flexible for end-users. For more information, please refer to the 'universal control command_12in1.xls', you can download it from FTP:

[ftp://59.41.255.150/en\(enlish\)/HDL%20Buspro/HDL%20Buspro%20Products/Sensors/SB-CMS-12in1/](ftp://59.41.255.150/en(enlish)/HDL%20Buspro/HDL%20Buspro%20Products/Sensors/SB-CMS-12in1/)

■ **Link Page:**

Enables a user to turn immediately to a designated page.

■ **Logic Light Adjust:**

Work with SB-DN-48DMX module.

■ **Logic Scene:**

Work with SB-DN-48DMX module.

■ **LCD&LED Sleep:**

Enables a user to control the brightness of LCD and LED.

3.4 AC Page

Support 9 areas independently, only the first 3 ACs support UV switch control, means AC1/AC2/AC3 can work with old IR emitter module (SB-IR-EM), 8in1, 12in1.

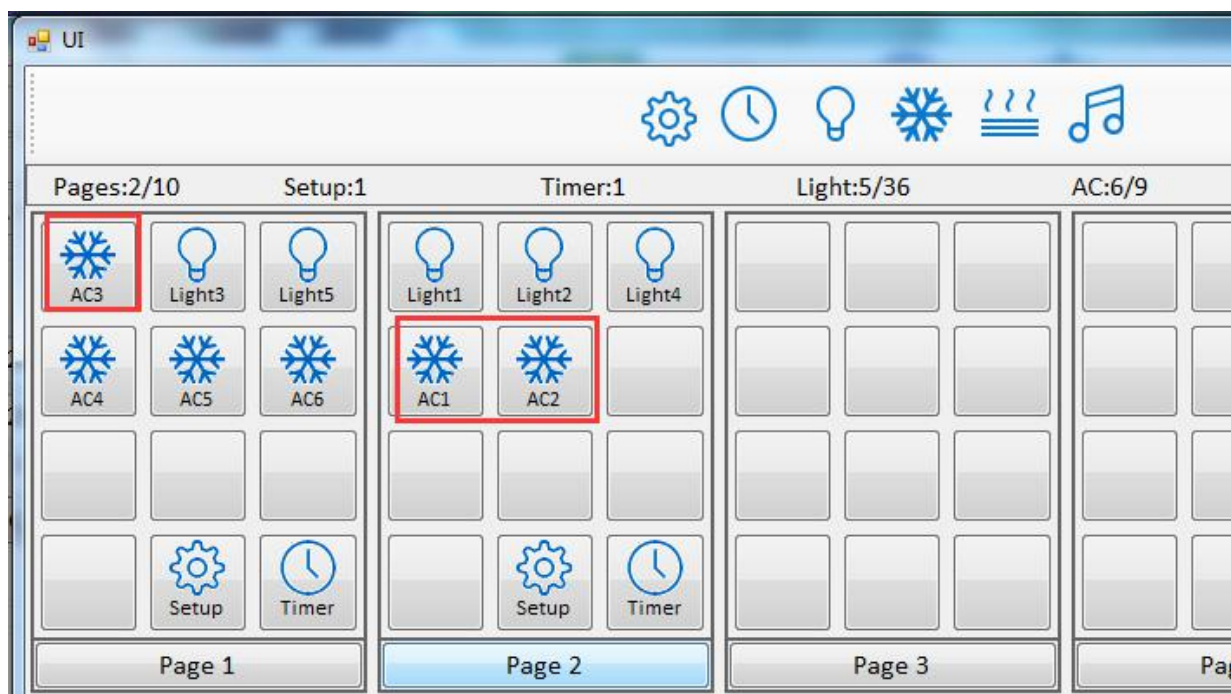

Choose AC:

Take below picture as an example

1-(In Page-2) means AC1 in page2.

3-(In Page-1) means AC3 in page1.

6-(In Page-1) means AC6 in page1.

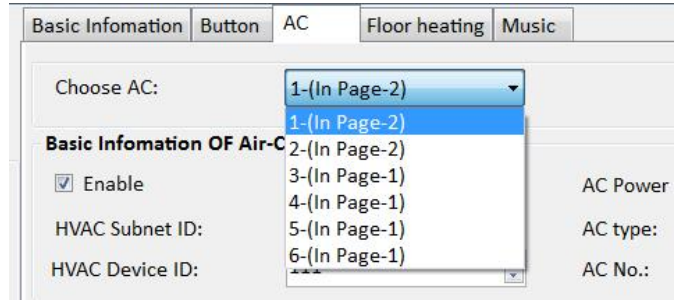

AC Setup:

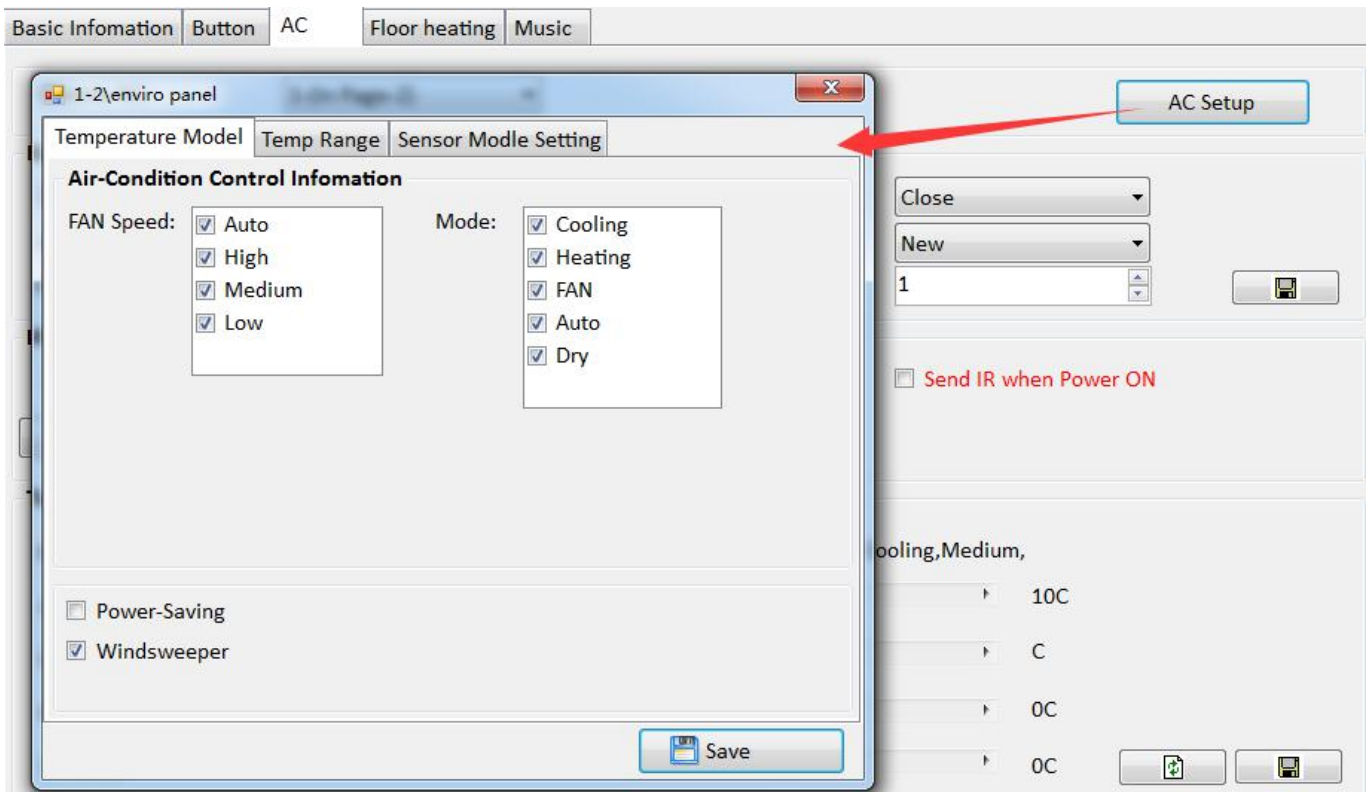

➤ Temperature:

FAN Speed and Mode: If selected, then speed/mode can show on the panel AC page.

Power-Saving: When the room temperature reach to the set point, then FAN relay channels will be off.

Wind sweeper: Enable/disable the wind sweeper. After selected, the wind sweeper icon will display on the panel AC page.

➤ Temp Range:

Enable the set point temperature range for different modes respectively.

➤ Sensor Module Setting:

Refer to internal sensor: use the temperature sensor which inside the panel.

Refer to outdoor sensor: use other module's temperature sensor.

Refer to average value: use the average value of internal sensor and outdoor sensor.

Test and control section:

Use for test the AC control in software.

Wind: After selected, will display the wind button on the AC page.

The screenshot shows a control panel titled "Test and control section". It contains the following elements:

- Running temperature: 28C
- Running state: Cooling,Low,
- AC power on: Open (dropdown menu)
- Cooling: 10C (slider control)
- FAN speed: Low (dropdown menu)
- Heating: C (slider control)
- Mode: Cooling (dropdown menu)
- Auto: 0C (slider control)
- Wind: Wind
- Dry: 0C (slider control)
- Two buttons at the bottom right: a refresh button and a save button.

3.4.1 HVAC Control

Can control the HVAC module or new IR emitter module (HDL-MIRC04.40)

Basic information Button AC Floor heating Music

Choose AC: 1-(In Page-2) AC setup

Basic information of air-condition

Enable Control AC running AC power on state: Close

HVAC subnet ID: 1 AC type: New

HVAC device ID: 111 AC NO.: 1

Enable: Enable/disable AC function.

Control AC running: After selected, panel in fully control mode, in charge of the controlling, and the HVAC is just a simple actuator.

When HVAC in 'slave control', panel must enable 'Control AC running'.

When HVAC in 'fully control', panel must disable 'Control AC running'.

If use HDL-MIRC04.40, no need to enable 'Control AC running'.

AC power on state: After power on again, can restore to the last status before power off, or Close it.

HVAC subnet ID/device ID: Fill in the ID of HVAC module.

AC type: If control MAC01.331, HDL-MIRC04.40, or RS232(AC version), then need to select 'NEW'. For old HVAC, select 'OLD'.

AC No: MAC01.331 just can control one AC, so the AC number is 1. But for HDL-MIRC04.40, or RS232(AC version) can control more ACs, so need to fill in the corresponding AC number.

3.4.2 UV Switch Control

Control the AC via IR codes. Works with old IR emitter (SB-IR-EM), 8in1, 12in1.

Notice:

- 1: Only AC1, AC2, AC3 can use UV switch command to control AC via IR codes.
- 2: Need to enable AC function and enable IR control function.

The screenshot shows a web-based configuration interface for an AC system. At the top, there are tabs for 'Basic information', 'Button', 'AC', 'Floor heating', and 'Music'. The 'AC' tab is selected. Below the tabs, there is a 'Choose AC:' dropdown menu set to '1-(In Page-2)' and an 'AC setup' button. The main configuration area is divided into sections: 'Basic information of air-condition' and 'IR function'. In the 'Basic information of air-condition' section, the 'Enable' checkbox is checked and highlighted with a red box. Other options include 'Control AC running' (unchecked), 'AC power on state' (set to 'Close'), 'HVAC subnet ID' (set to '1'), 'HVAC device ID' (set to '111'), 'AC type' (set to 'New'), and 'AC NO.' (set to '1'). In the 'IR function' section, the 'Enable/Disable IR' checkbox is checked and highlighted with a red box. Other options include 'IR automatic control' (unchecked) and 'Send IR when power on' (unchecked). There is also an 'IR control targets configuration' button at the bottom of the section.

IR automatic control:

You only need to use it when the AC is not built-in algorithm, can not work in smart way. But mostly no need to use.

Enable/Disable IR:

Enable/disable the IR function. (If use UV switch command to control AC, then need to enable this function.)

Send IR when power on:

After power on again, DLP will trigger the last IR codes before power off.

IR control targets configuration:

Fill in the corresponding target in each AC state position.

Take the old IR emitter (SB-IR-EM) as an example:

1- Upload the IR codes to IR emitter module.

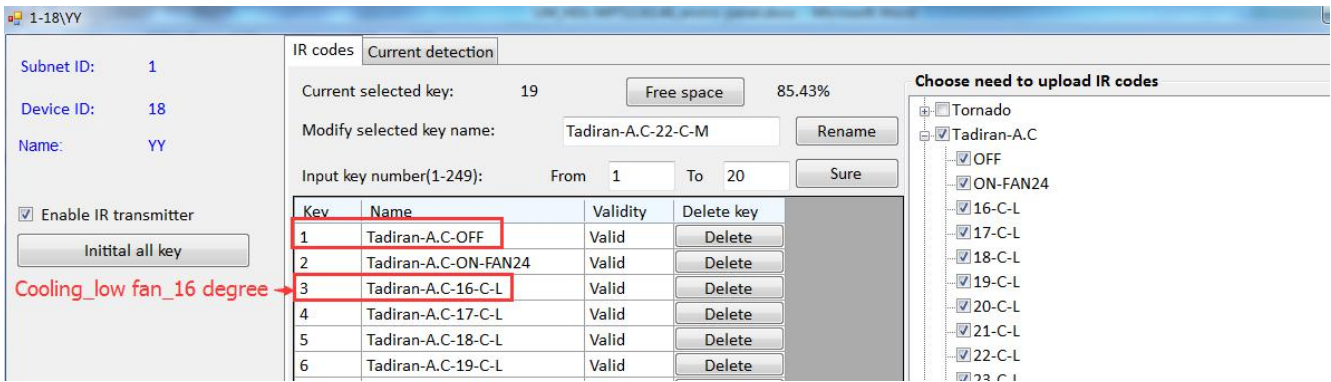

2- In panel AC setting page, click 'IR control targets configuration'. Find the AC status, for example 'OFF'. And fill in the target.

See above picture, the OFF code is in Key1, so in the panel setting, Parameter1 is 1, and Parameter2 always is ON.



3- For example 'cooling, low fan, 26 degree'.

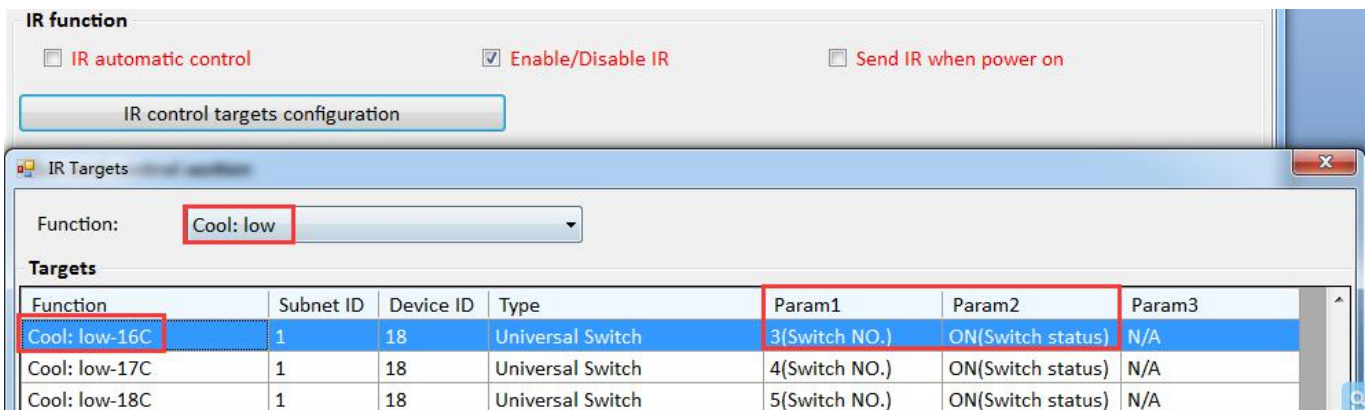

4- Do the same steps to set other codes.

3.5 Floor Heating Page

Enviro panel supports 9 areas of floor heating, and each area can work independently.

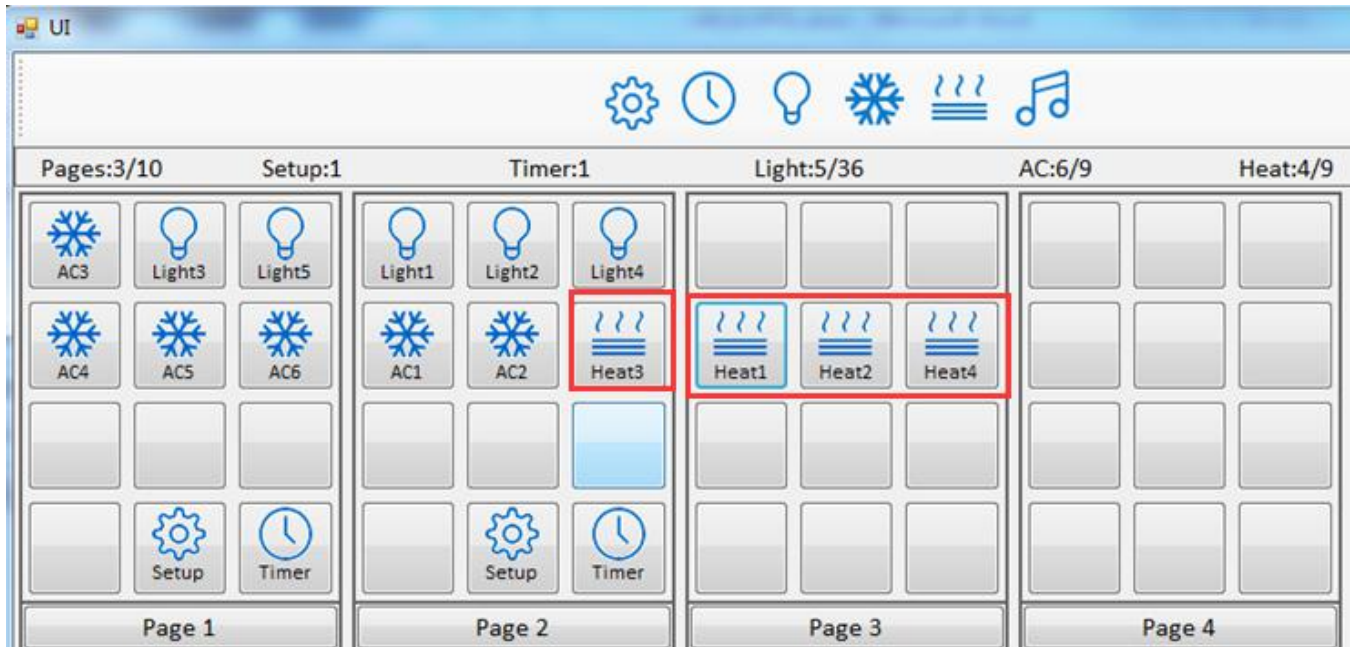

Choose FH:

1-(In Page-3) means heat1 in page3.

2-(In Page-3) means heat2 in page3.

3-(In Page-2) means heat3 in page2.

4-(In Page-3) means heat4 in page3.

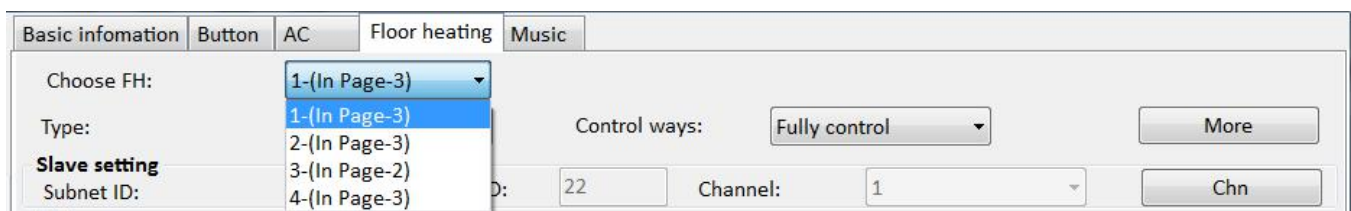

There are two ways to control the floor heating:

Way1: Panel in ‘Fully control’ mode, and control the floor heating channel which in the Slave control mode or relay module channel.

1- Fill in the control target (floor heating/relay), for example channel 1 of 1-16.

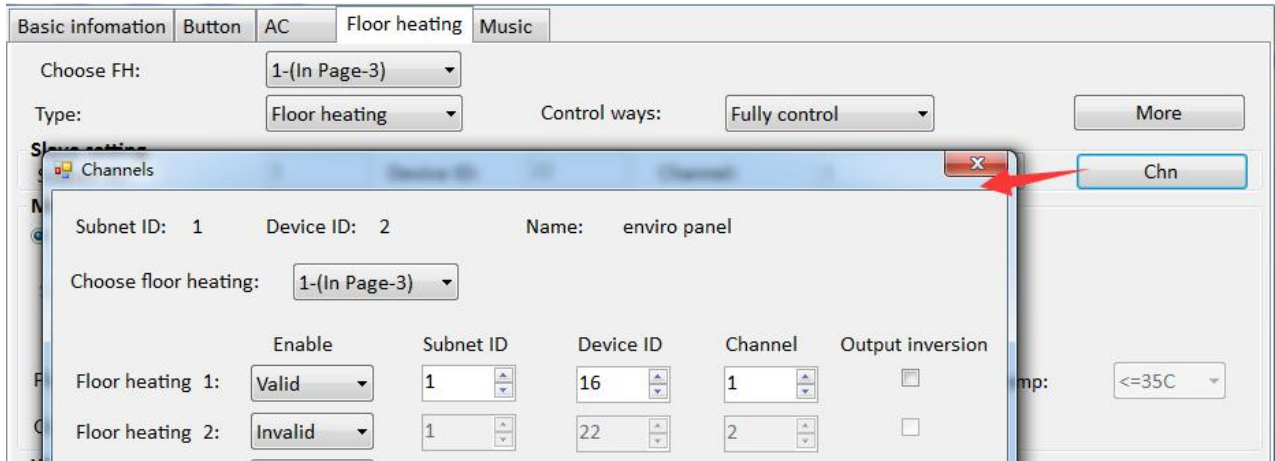

2- Choose the temperature sensor.

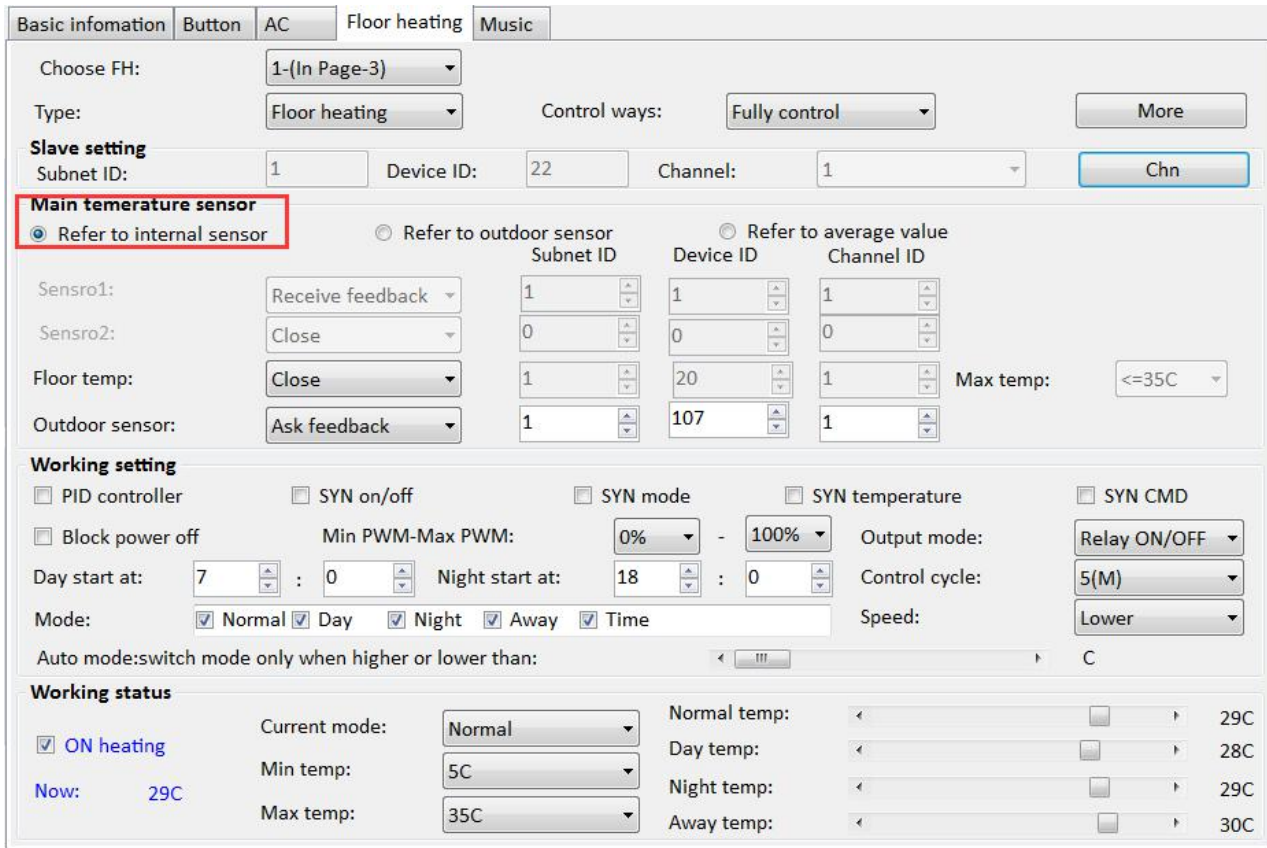

3- If control the floor heating module, floor heating module must in Slave control mode.

Way2: Panel in Slave control mode. And the floor heating module must in 'Fully control' mode.

1- Panel select 'Slave control' mode, and fill in the ID/channel of floor heating module.

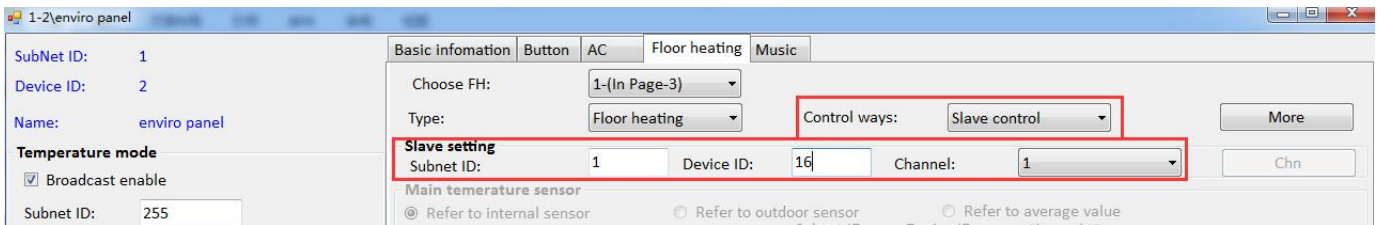

2- Floor heating module select 'Fully control' mode. For more settings in floor heating module, please refer to its user manual.

Floor heating page display in panel:

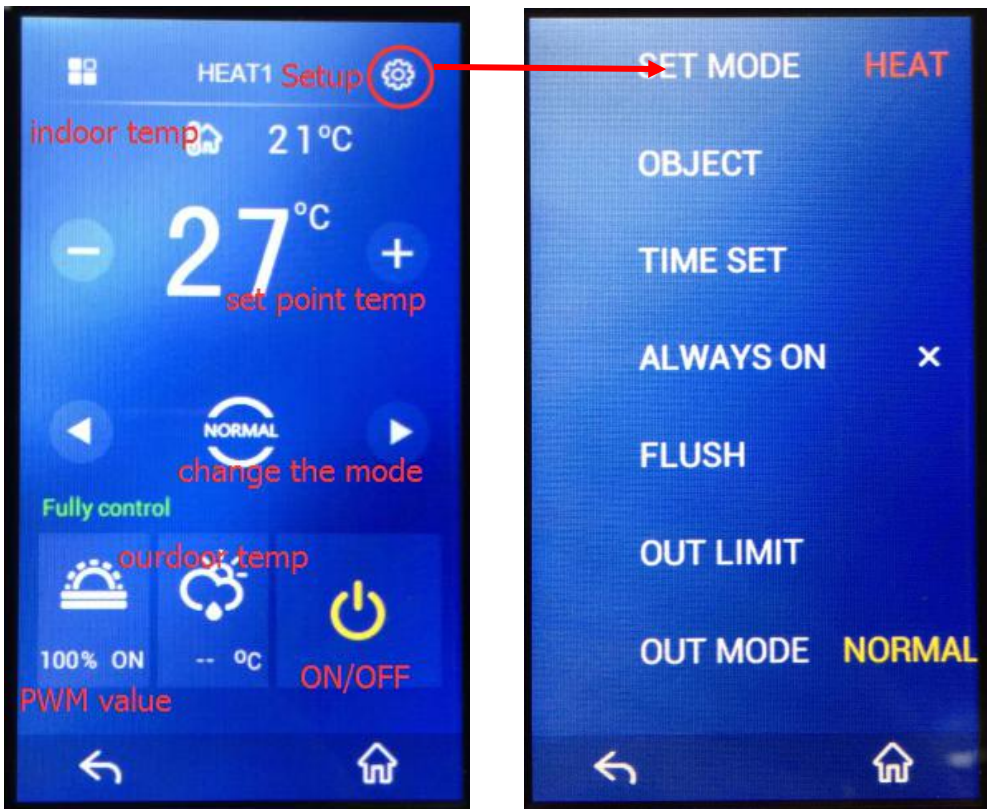

3.6 Music Page

Enviro panel supports 9 areas of music, and each area can work independently.

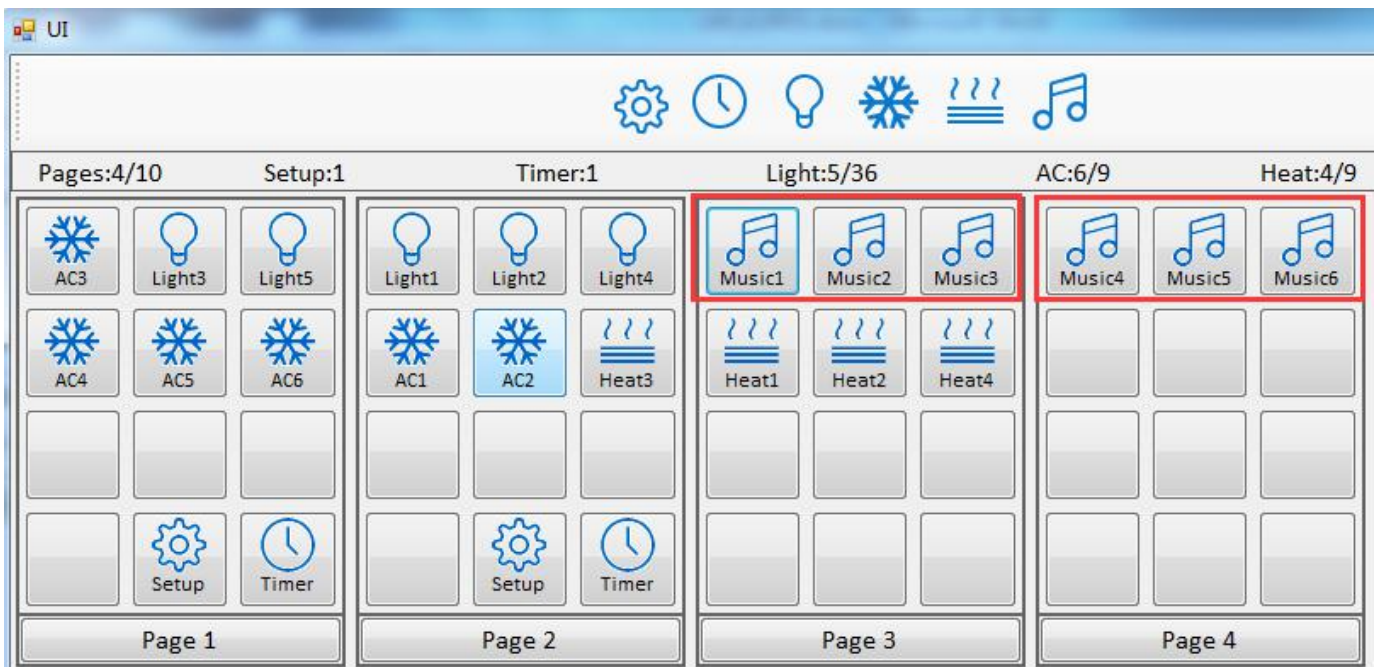

Choose music:

- 1-(In Page-3) means Music1 in page3.
- 2-(In Page-3) means Music2 in page3.
- 3-(In Page-3) means Music3 in page3.
- 4-(In Page-4) means Music4 in page4.
- 5-(In Page-4) means Music5 in page4.
- 6-(In Page-4) means Music6 in page4.

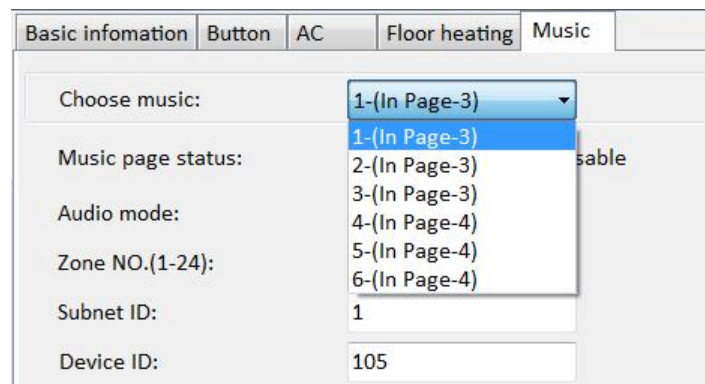

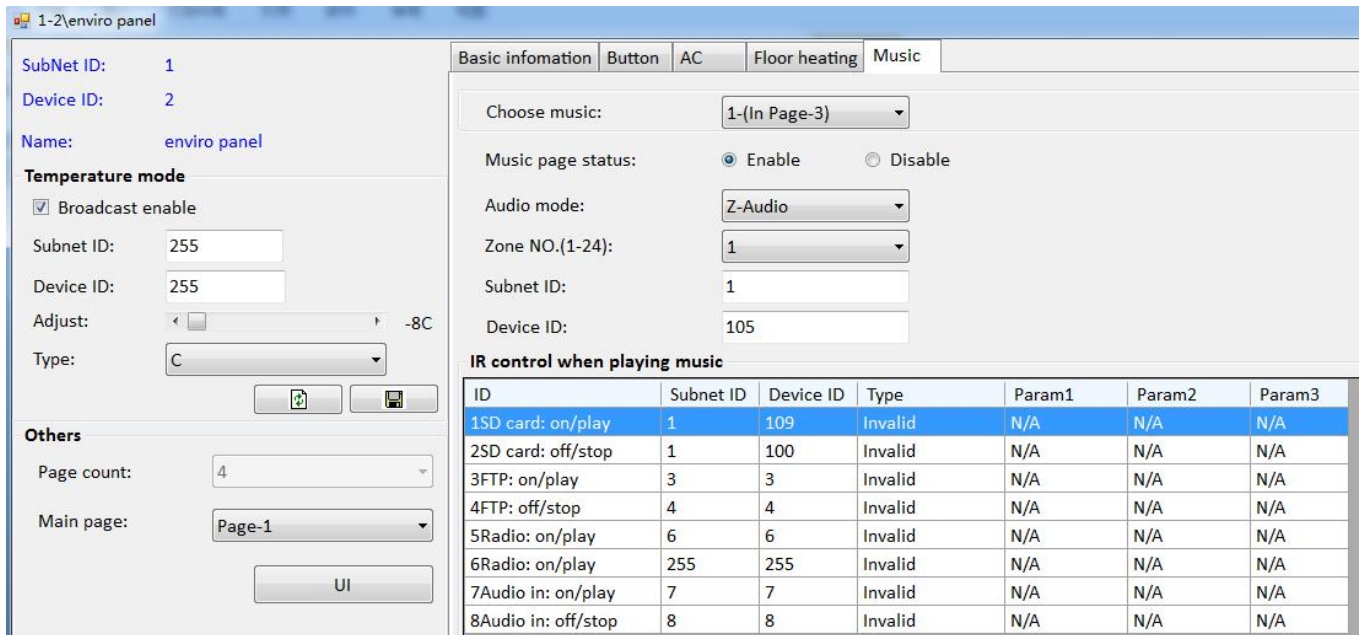

Audio mode:

Z-Audio: If control HDL music player, need to select Z-Audio.

NUVO: If control 3rd party music player, need to select NUVO.

Zone NO. (1-24):

Total 24 zones, means can control 24 music players in panel independently; when you play the songs, you can select the zone number on the panel.

ID:

Fill in the ID of music player.

IR control when playing music:

Set the additional targets when playing music.

For example:

When playing SD card music, can trigger the targets in '1SD card: on/play'.

When stopping SD card music, can trigger the targets in '1SD card: off/stop'

Music page display in panel:

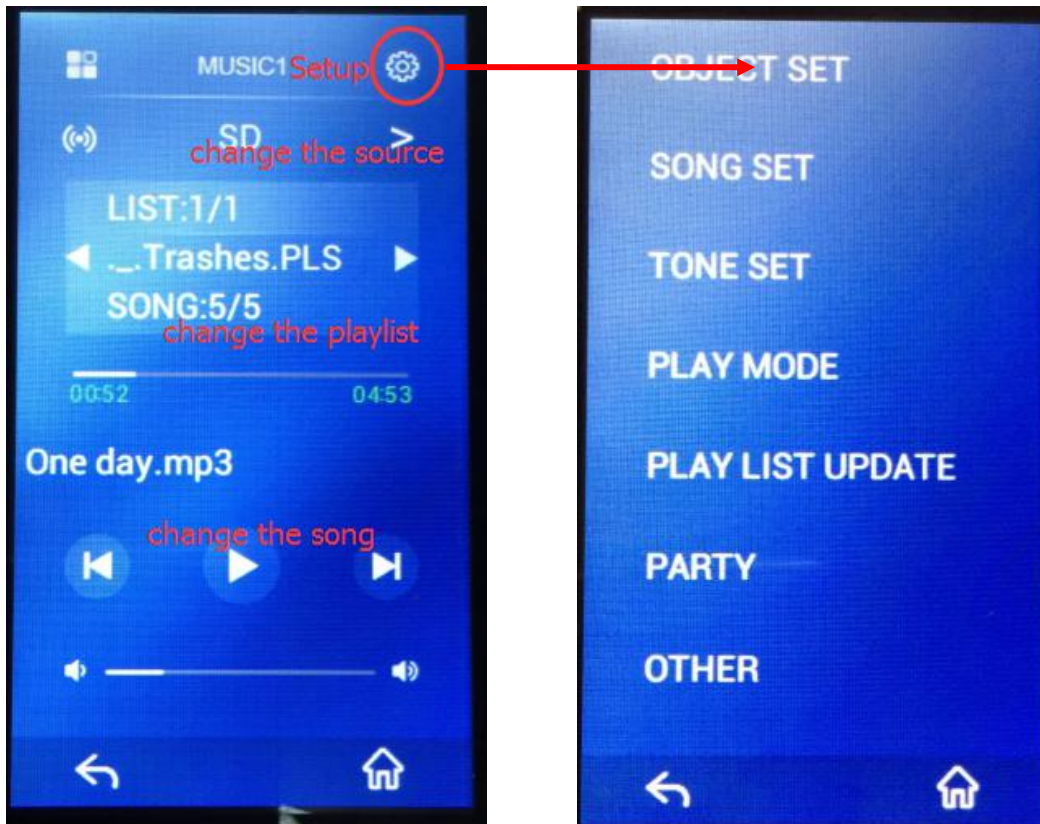

OBJECT SET: Can check/change the playing zone and music address.

SONG SET: Play the specific song.

TONE SET: Can set the value of Bass/Treble.

PLAY MODE: Set play mode, they are Continued/Repeat all/Play one/Repeat one.

PLAY LIST UPDATE: Use for updating the playlist.

PARTY: Enable/disable the party mode.

OTHER: Set the control way, PLAY/STOP or PLAY/PAUSE. For old music player (SB-Z-Audio), just supports PLAY/STOP mode.

3.7 Modify the Icon and Remark

Take below UI as example, we can modify the icon/remark which display on the panel.

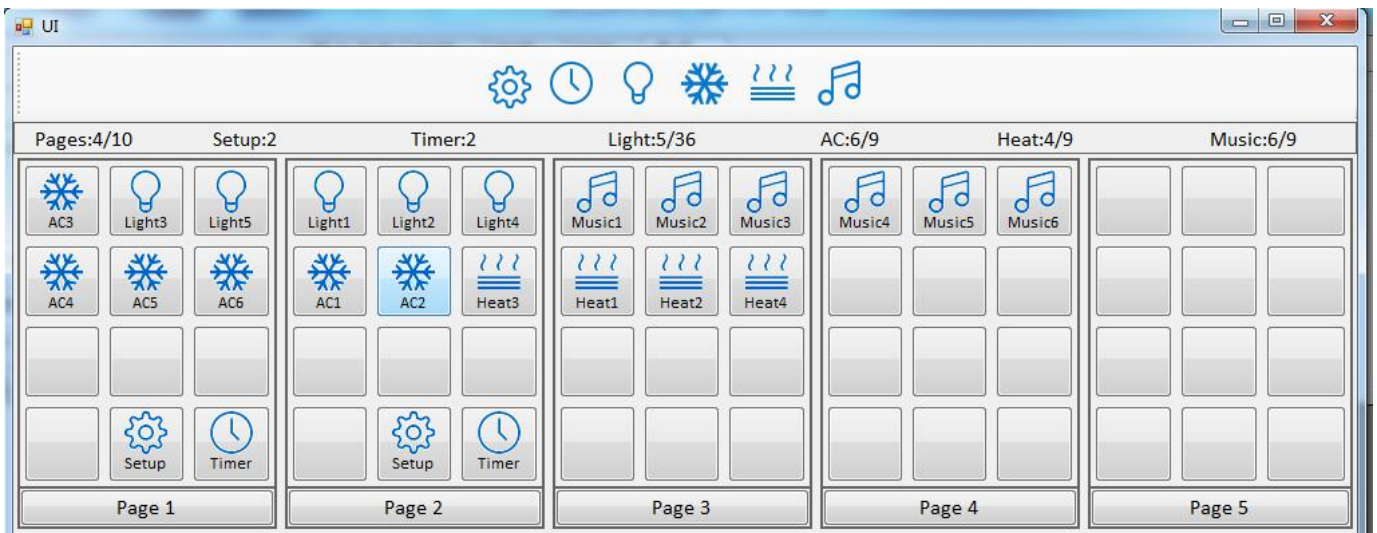
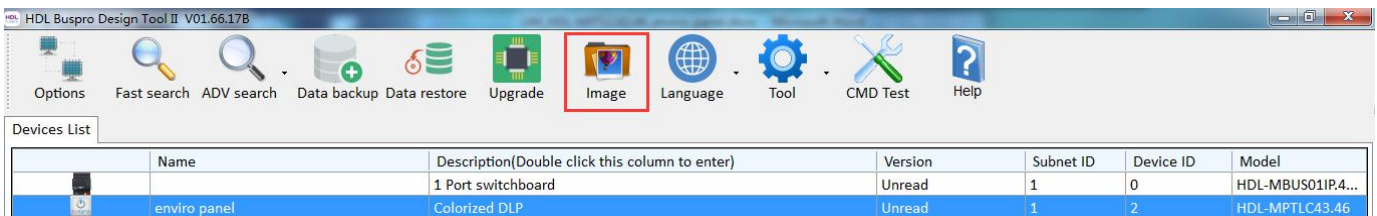

Image format is png, icon size is 46×46mm, background picture side is 272×480mm.

Steps:

- 1- Searched the enviro panel.
- 2- Click 'Image', enter to the setup page.



- 3- Select panel, and select which page need to modify.

4- Double click the icon frame, can add the new icon.

5- Add the remark in the text frame.

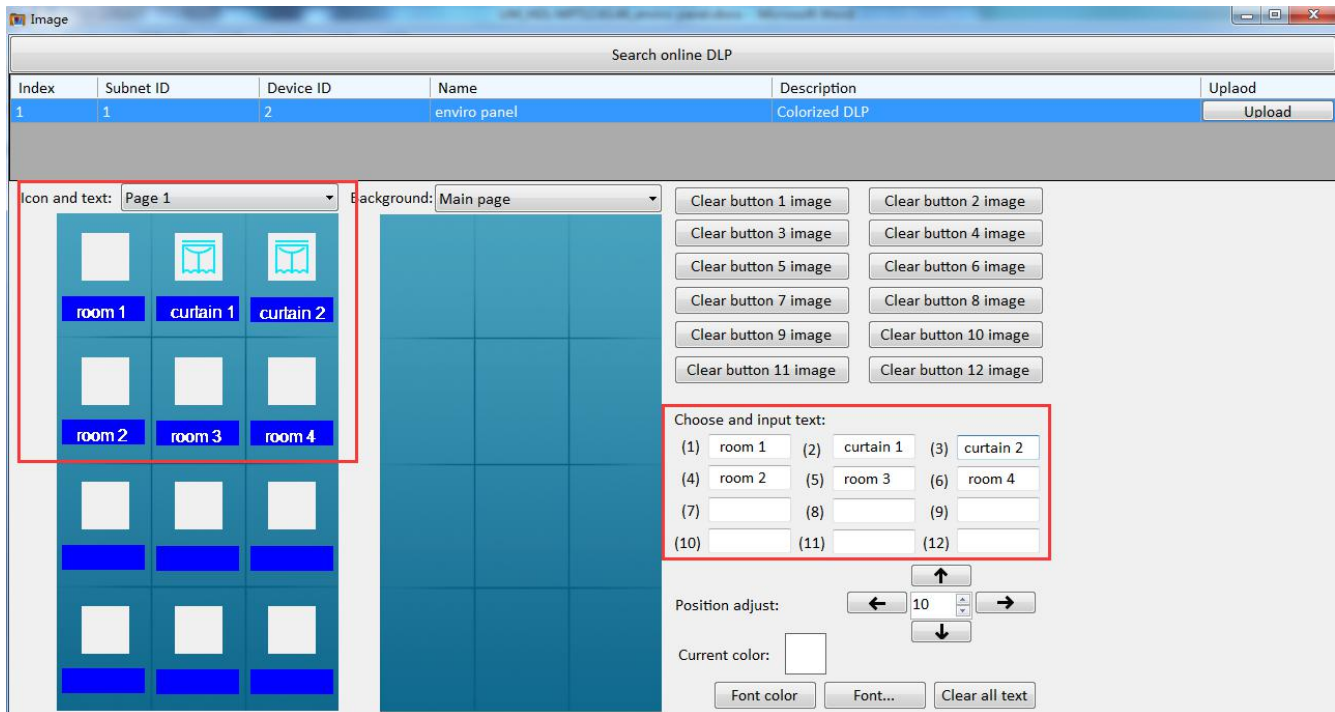

6- Click Upload,

Click 'Icon image', upload the icon.

Click 'Label image', upload the label.

Click 'Background image', upload the background picture.

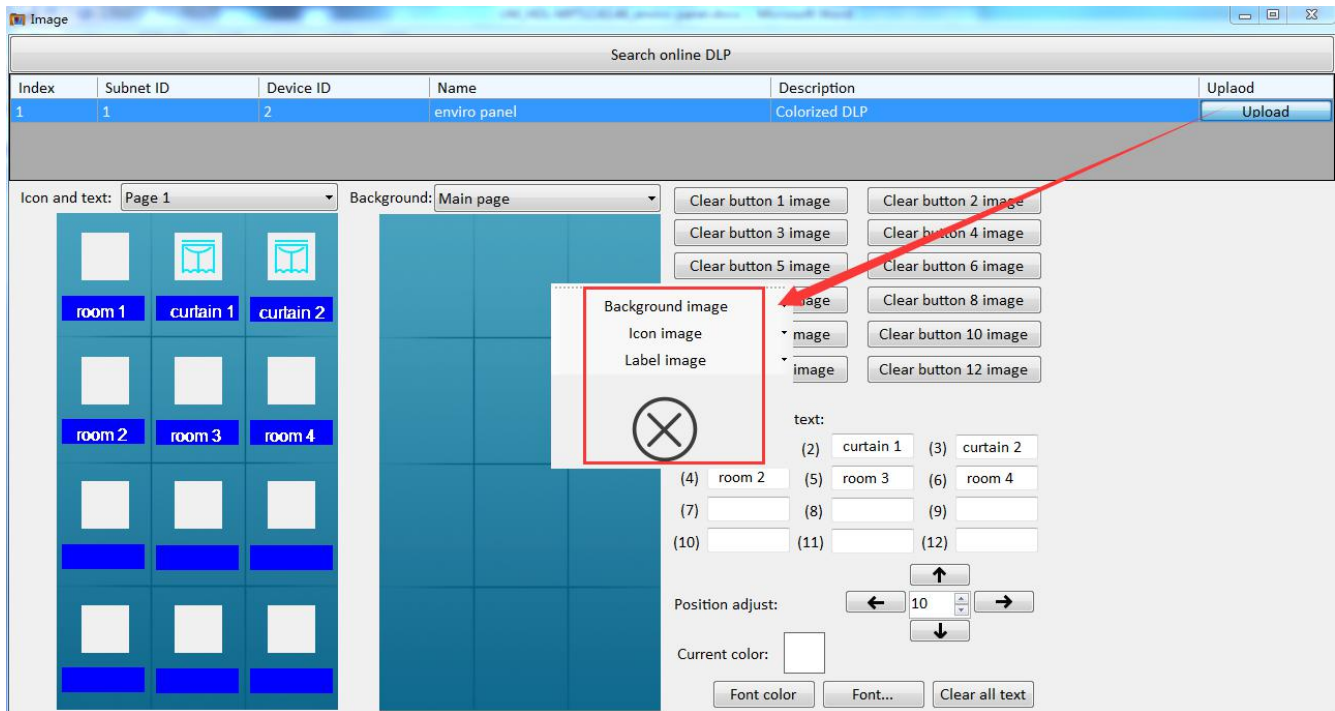

7- After uploaded, the panel will display as below:



Notice:

We can change the icon/remark which display on the panel, but it will not effect the UI design page. The ID/position in UI page is unchangeable.



3.8 Upgrade

Enviro panel supports Automatic Upgrade and Manually Upgrade.

Automatic Upgrade:

- 1- Searched the enviro panel, and click Upgrade.
- 2- Select the enviro panel and upgrade file.

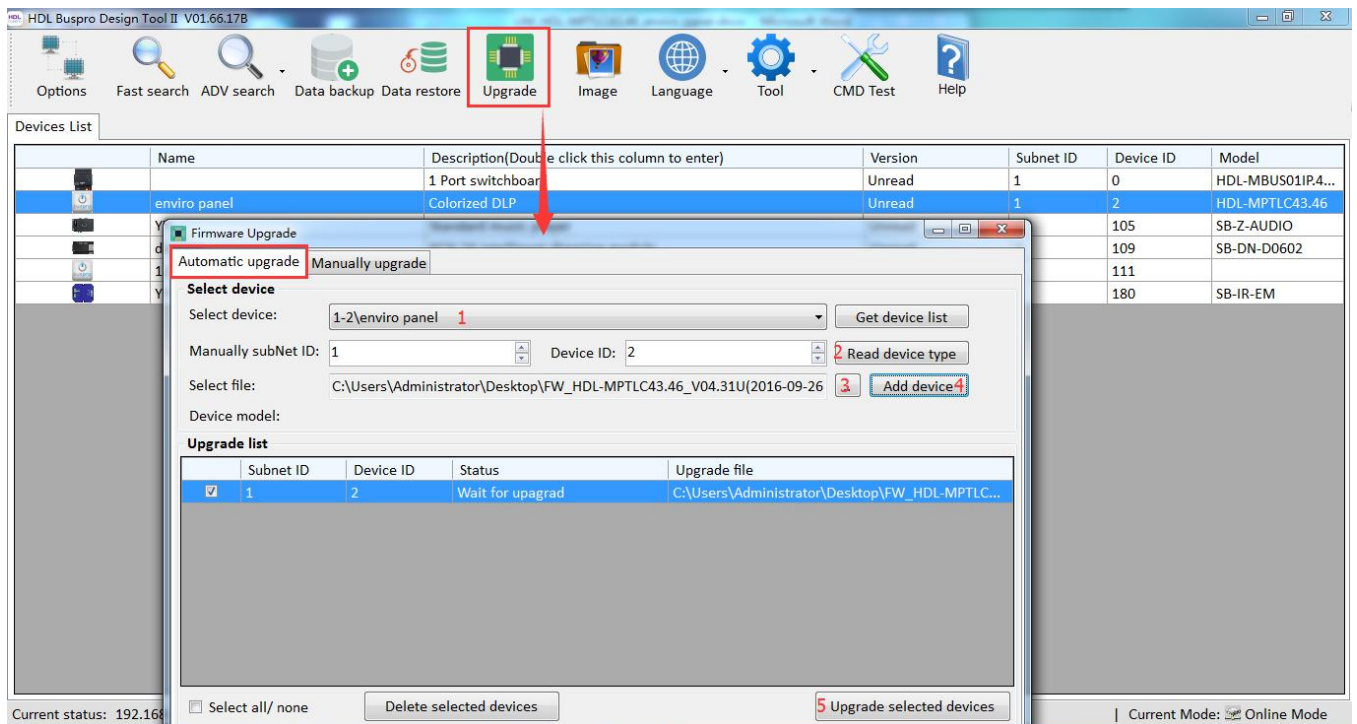

3- Done.

Manually Upgrade: If automatic upgrade failed, you can try Manually upgrade.

1- Power off the enviro panel.

2- Power on the enviro panel, it will shows 'WELCOME' on the screen, and then long press the screen, the screen will be green color and shows UPDATE...

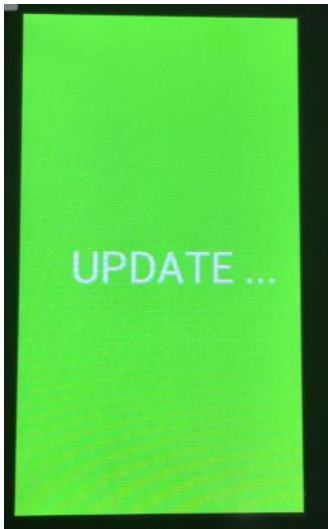

3- Go to manually upgrade page, it will shows the panel ID automatically. Select the upgrade file and upgrade it.

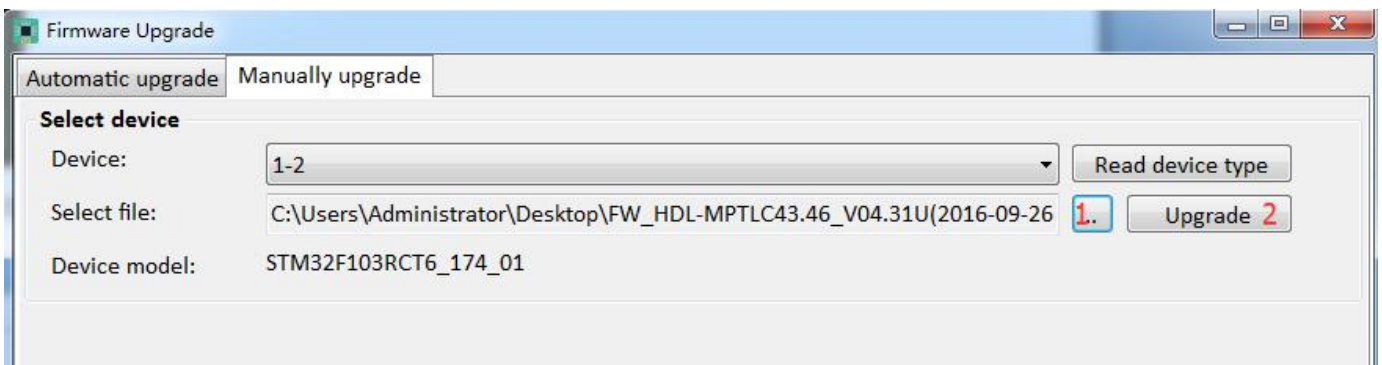

4- Done.

4. Customer Service and Technical Support

HDL is proud to provide its clientele with the very best automation products possible. If you require support from HDL, please do not hesitate to contact our Customer Service or Technical Support teams.

Customer Service

Email: kfzl@hdlchina.com.cn

Phone: 0086 020-84651666

Fax: 0086 020-84860772

Technical Support

Email: support@hdlchina.com.cn

Phone: 0086 020-84651666-7302

Fax: 0086 020-84860772

Local Support

If you would prefer to speak to your local HDL representative, please visit the 'contact us' page from the HDL website (<http://www.hdlautomation.com/contact-us/>), and select your country's HDL representative from the drop down list.

Head Office

Guangzhou Hedong Electronic Co., Ltd

Address: No.24 jianzhong Road, Tianhe Development Zone of Hight&New Technology Estate, Guangzhou, 510665 China.

Tell: 0086 020-85521566

Fax: 0086 020-85520532

Factory base

Guangzhou Lichuang Electronic Co., Ltd

Address: No.86 Lotus west Road, Lifeng Street, Shilou Town, Panyu District, Guangzhou 511447, China.

Tell: 0086 020-84651666

Fax: 0086 020-84860772

Service hotline: 0086 020-85536533

www.hdlchina.com.cn

HDL[®]

HDL[®]